

PIANO URBANISTICO ESECUTIVO DEL COMPARTO 26/A

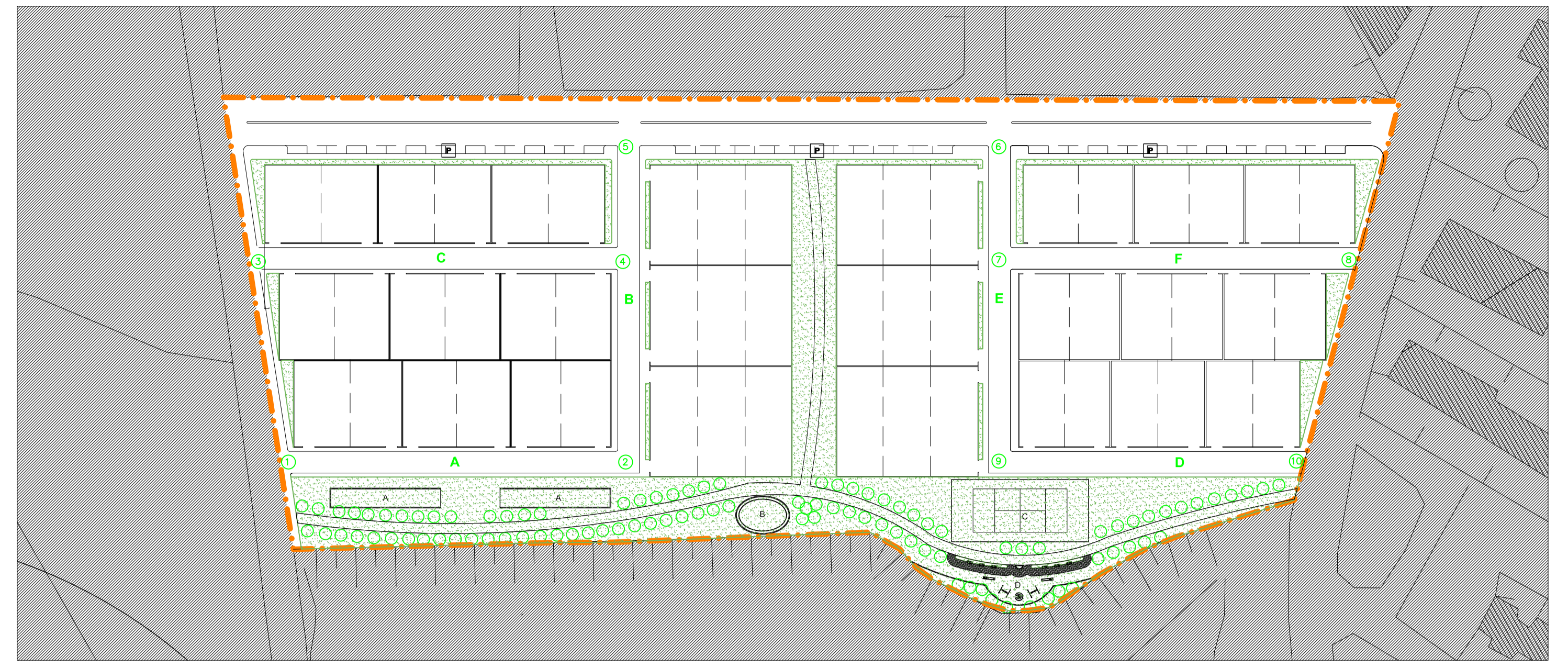

RETE IDRICO-FOGNARIA

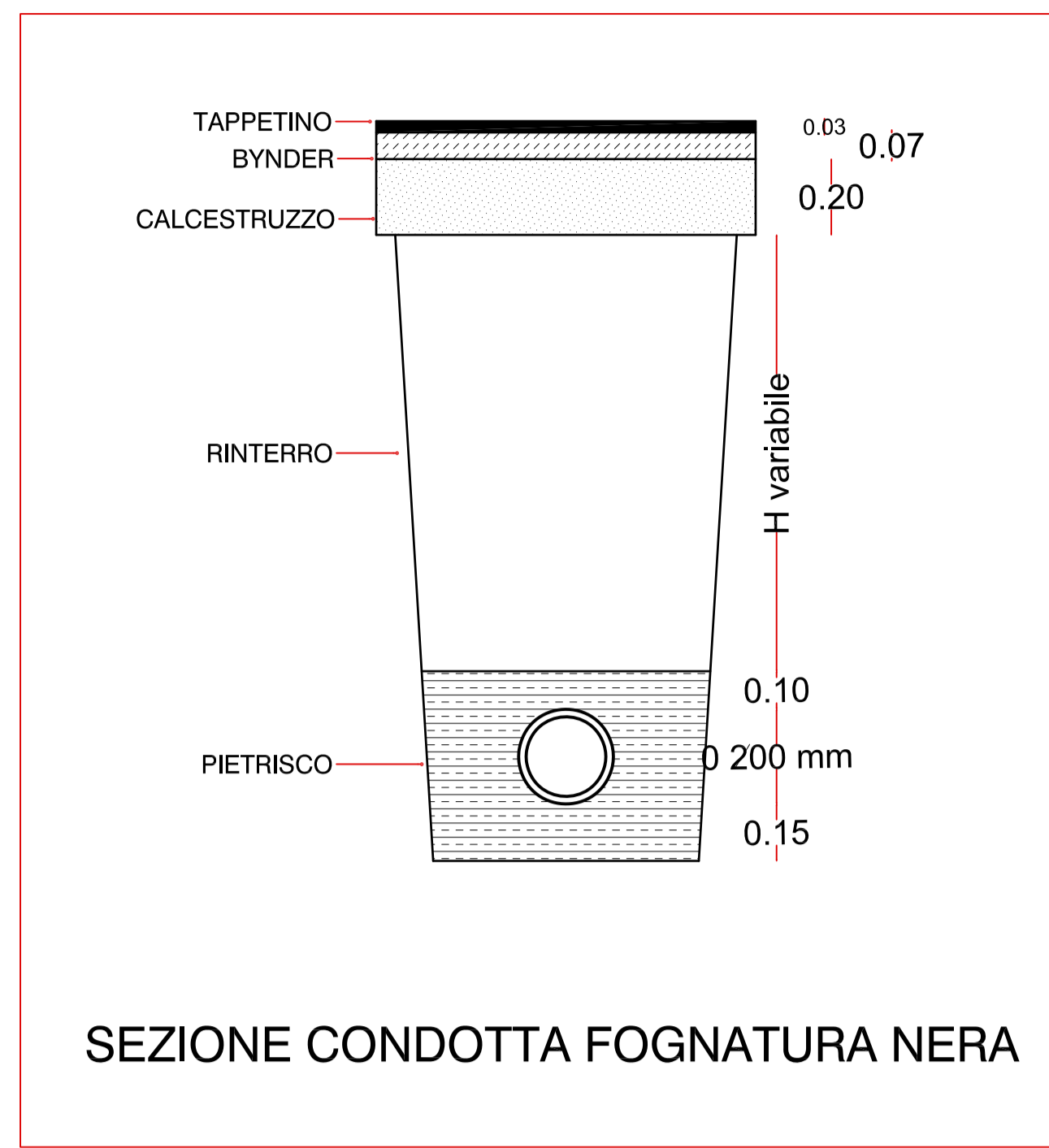

Scala 1:500 Giugno 2011

PROGETTISTA: Dr. Arch. Silvio Causo		Il Sindaco
COLLABORATORE: Dr. Arch. Francesca Cepulo Gianni Antonio Rizzo		
Delibera della G.C. n°..... del	Delibera del C. C. n°..... del	Aggiornamento del

RETI IDRICA E FOGNARIA
Planimetria scala 1:500

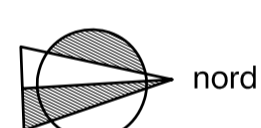
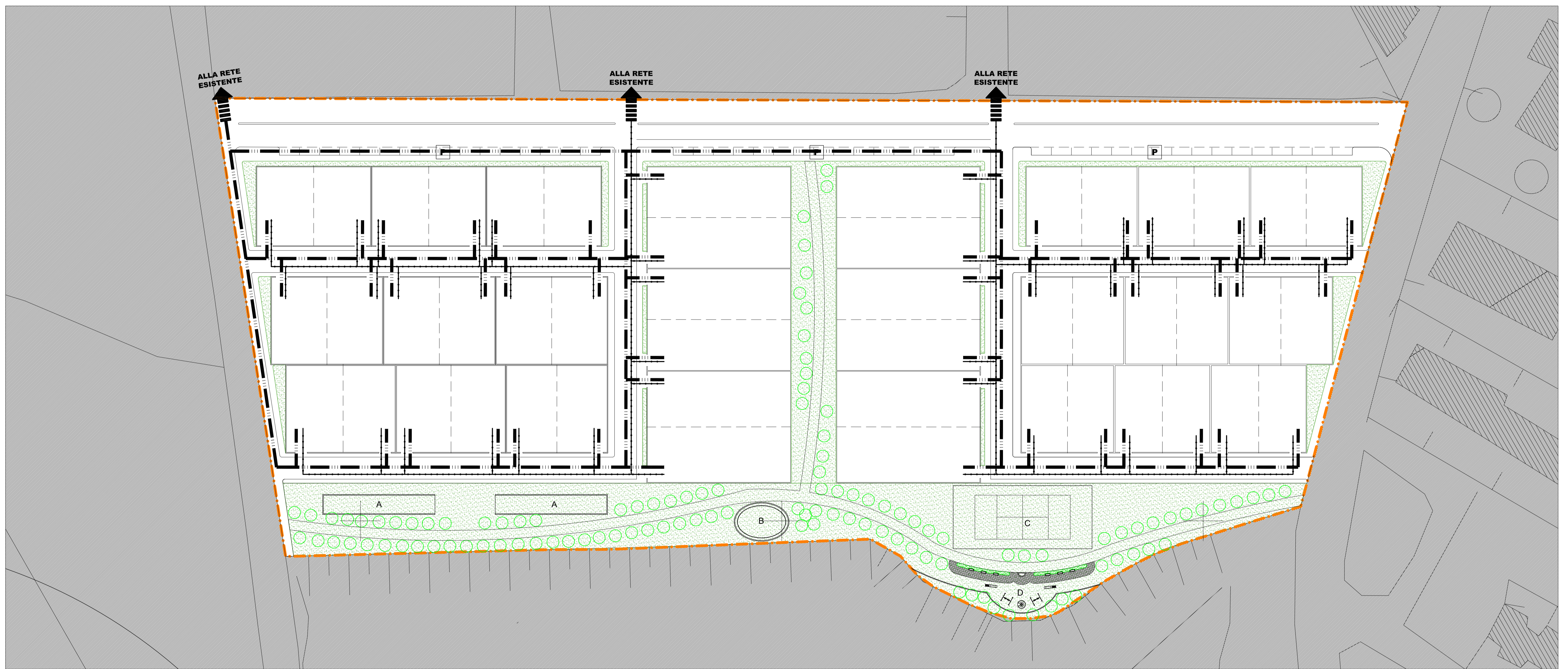

LEGENDA

- LIMITE COMPARTO
- RETE IDRICA
- RETE FOGNA NERA DI PROGETTO

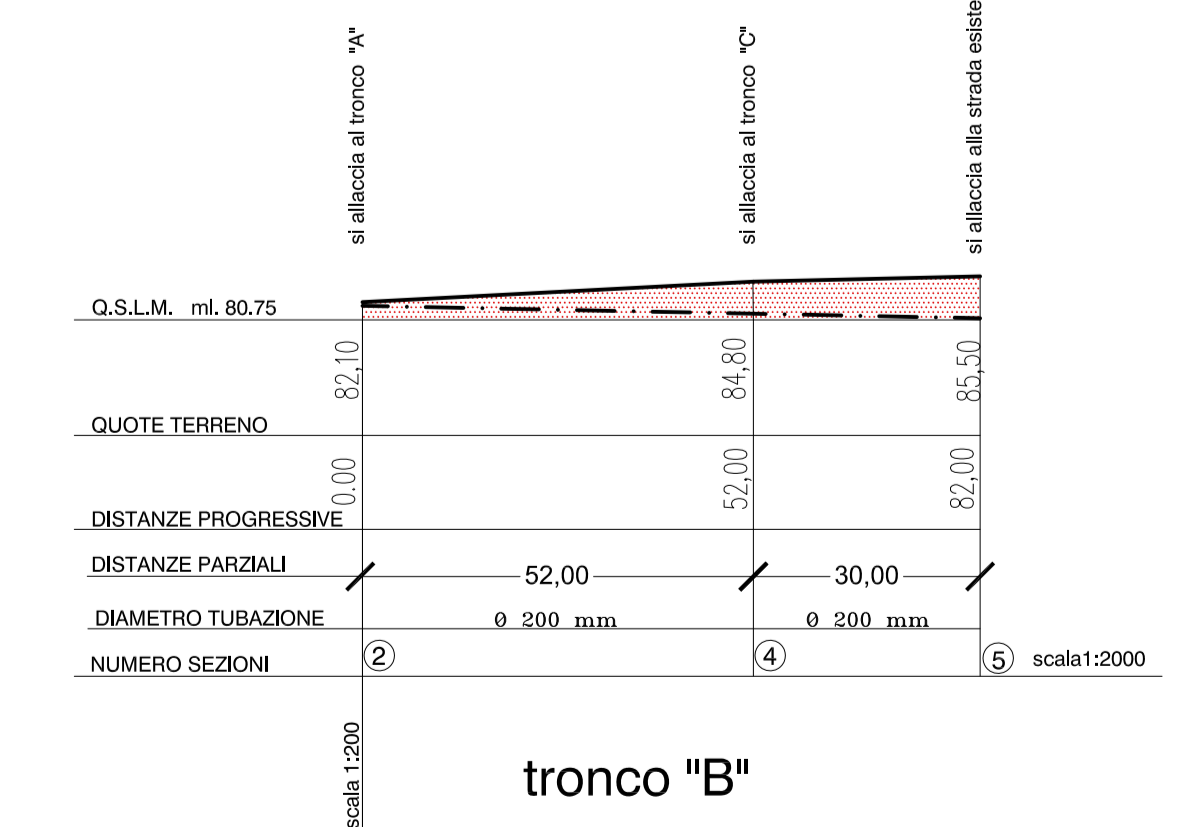
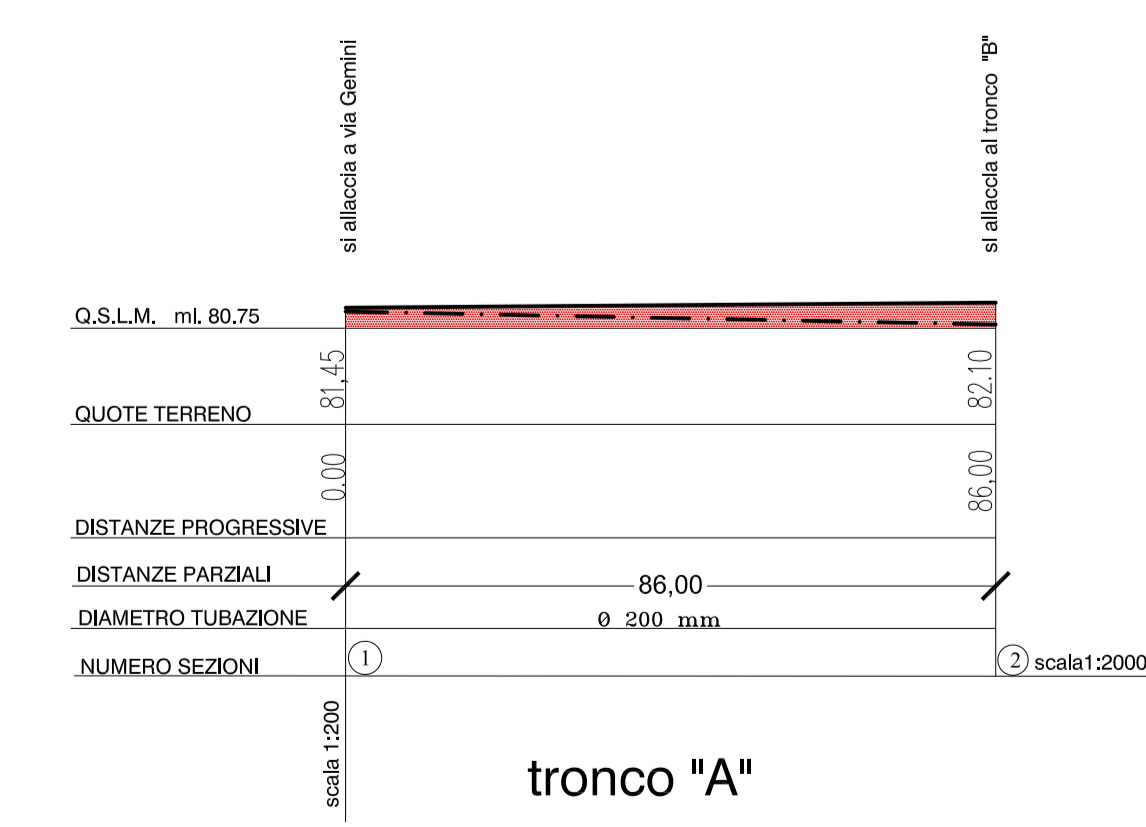
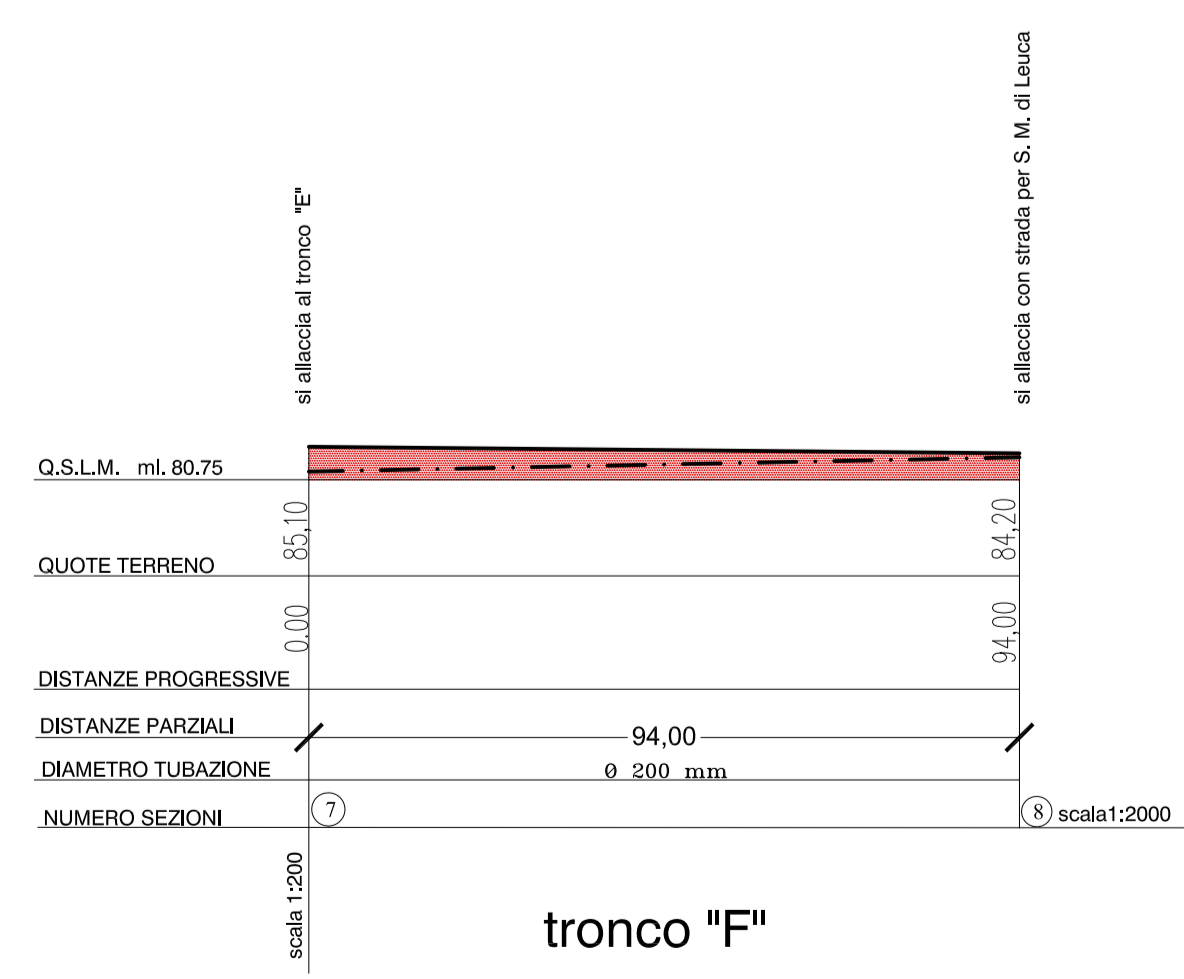
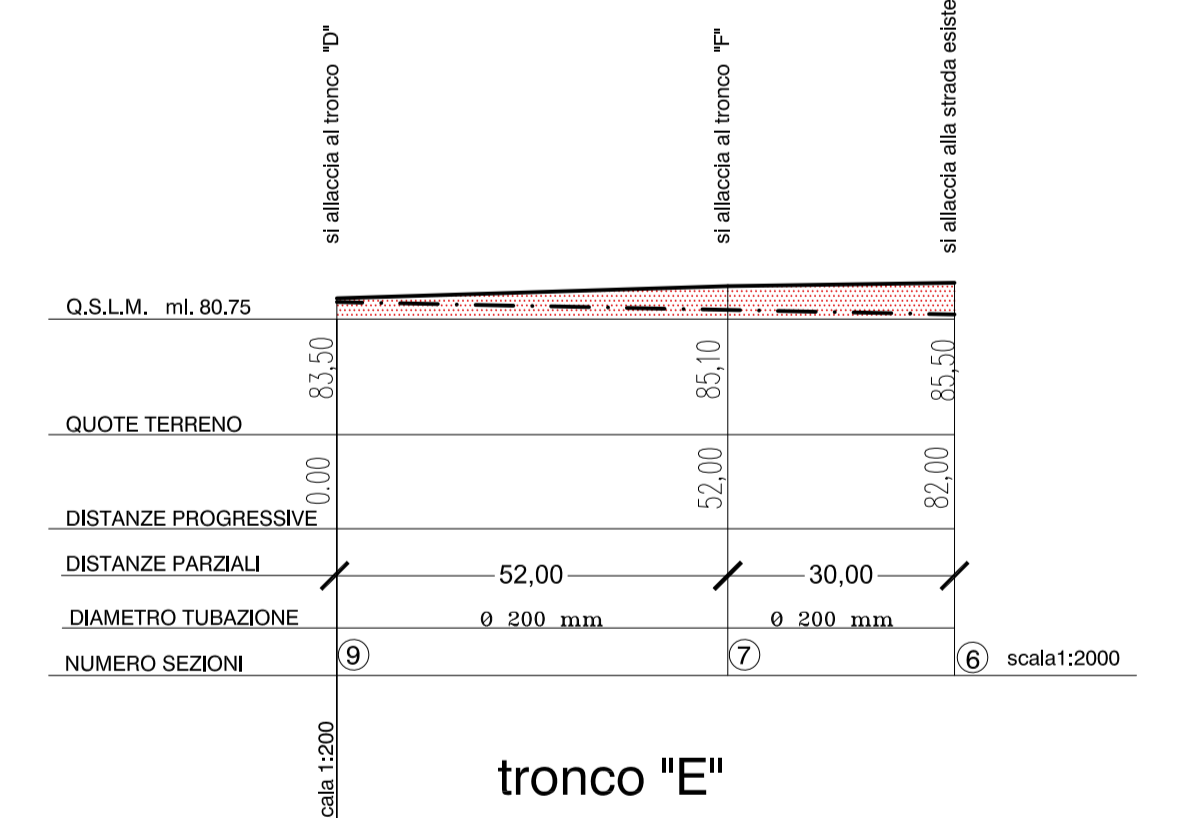
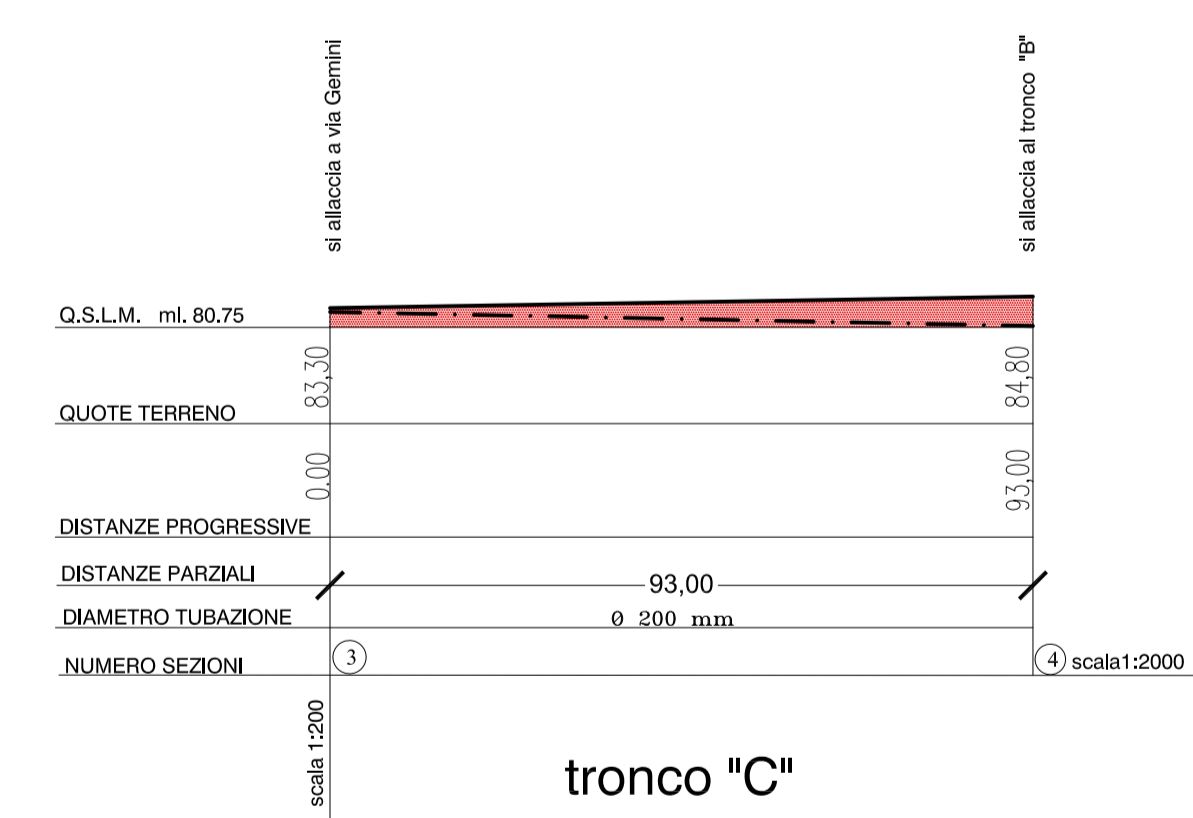
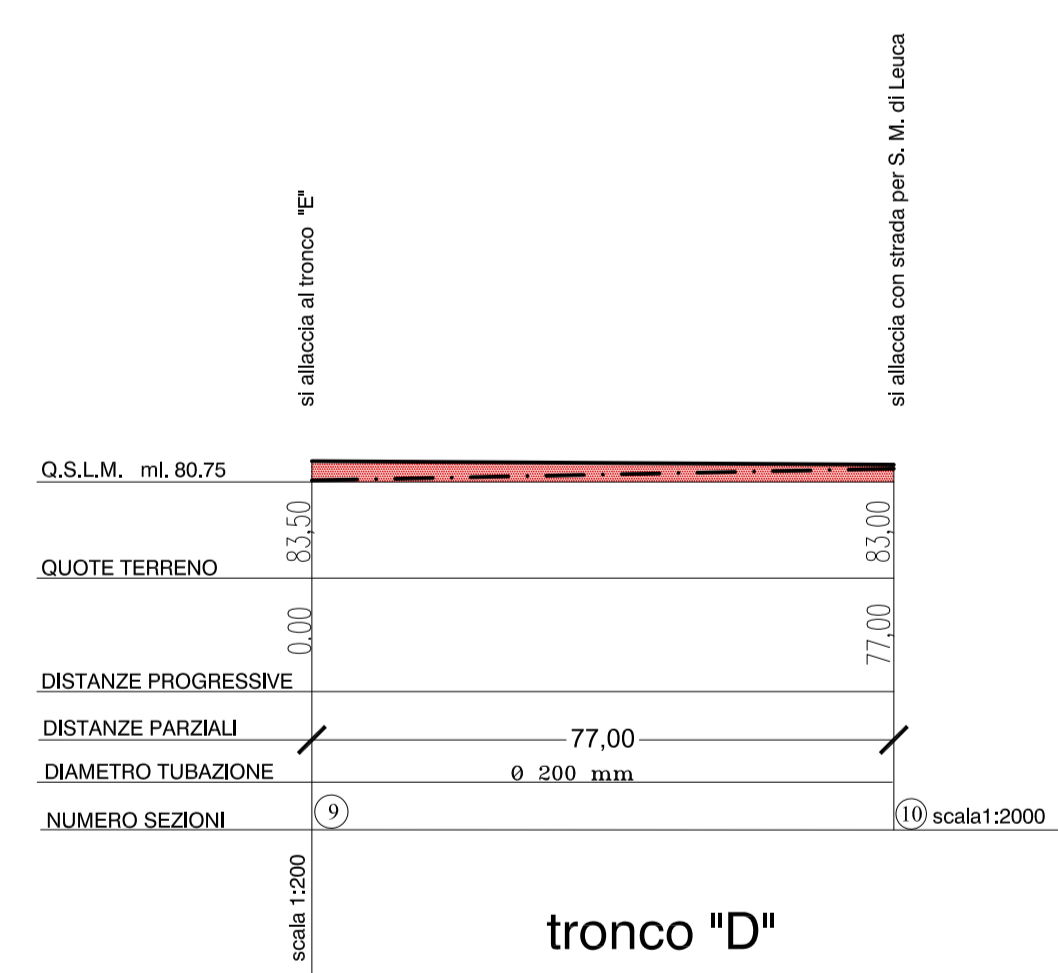

SEZIONI STRADALI - FOGNA NERA -